

Connection cables

Assembled round cables

HHC20 / HHC40 series 케이블은 사용자 길이에 맞게 제작되어 있으며 고객이 원하는 길이에 맞게 주문 제작도 가능하며 케이블 도체 굵기는 기본 0.25mm² (AWG24)입니다. 그러므로 사용자 효율을 최대한 높이고 케이블 종단을 기본 압착 후드 처리하여 프런트 커넥터와 단자 간 원터치 취부함으로 작업 공수를 획기적으로 단축할 수 있습니다.

- Combined digital and analog
- Per-assembled control cable
- Control cable 1 x 20 / 40 AWG 25 ~ 24
- One-touch connection
- Removable cable

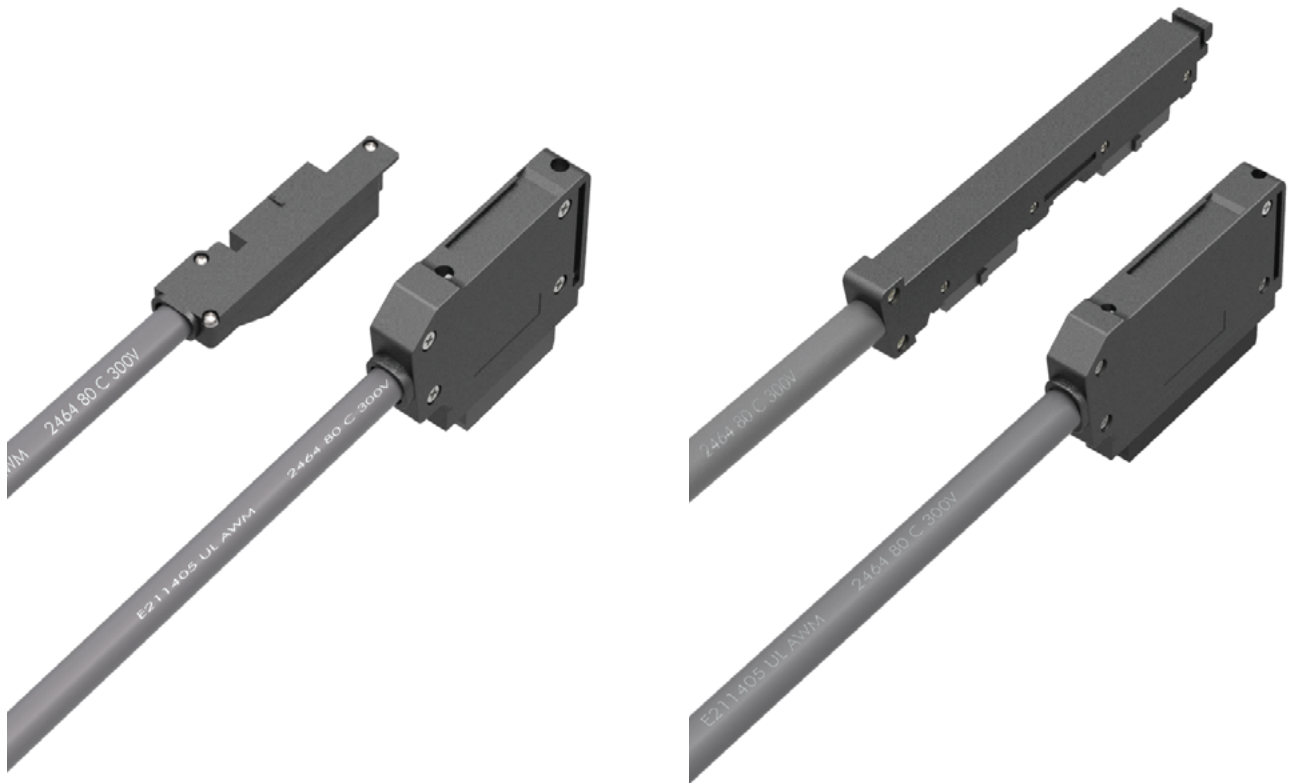

EZlink assembled round cables

HHC20 / HHC40 series

Product constitution

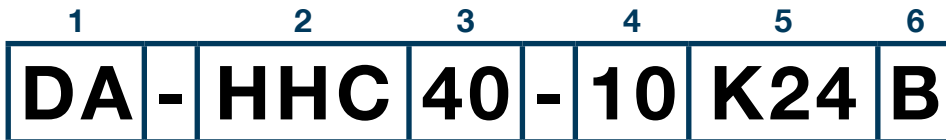

1. DA

- Digital / Analog
 - D : Digital
 - A : Analog

2. HHC

- Connector type

3. 40

- Contact Point

4. 10

- Length
 - 10 : 1M
 - 15 : 1.5M
 - 20 : 2M
 - ⋮
 - 100 : 10M

5. K24

- Thickness
 - K24 : AWG24(made in korea / UL)
 - K25 : AWG25(made in korea / UL)

6. B

- Fixation
 - B : Bolt
 - L : Laver

Assembled round 20P cable

Assembled round cable for SIMENS S7-300

ST650 AIO / ST800 / SR800

20P series



Dark gray

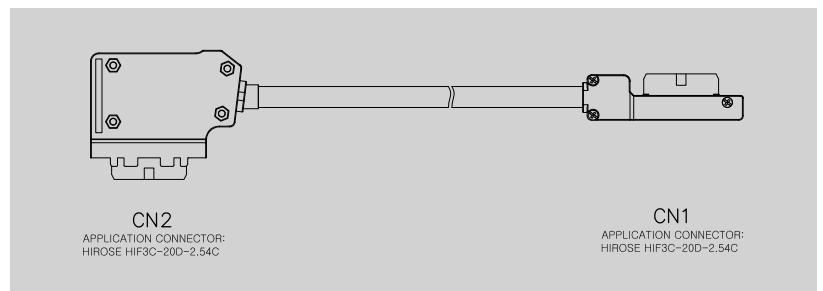

DAHHC20-□K24B / DAHHC20-□K25B

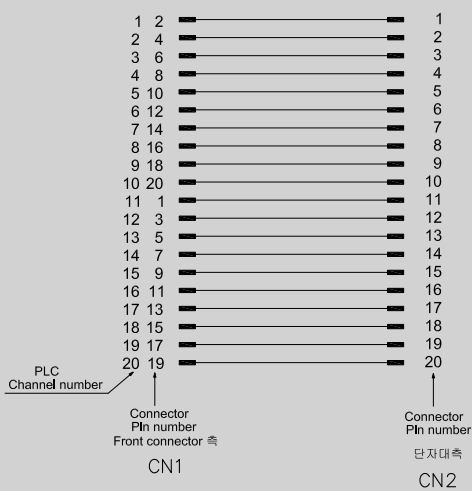

Technical data

Connection data	
Connection to PLC	HE 10 connectors 20-pin
Connection type	Onetooth connection
Connection size	0.25mm ² (AWG24) / 0.17mm ² (AWG25)

Rated data	
Number of signals	20 point
Rated voltage	120VAC / 50VDC
MAX. connector pin	1.5A
MAX. permissible summation current	17A

General data	
Ambient temperature	-10°C ~ 50°C
Storage temperature	-10°C ~ 60°C
Insulation test voltage	0.5KV DC
Weight	Approx. ---g

Dimensions	
Length x width x height (mm)	

Ordering data

Order No.	
042417001	

Accessories / Spare part

--	--

C

Assembled round 20P cable

Assembled round cable for SIMENS S7-300

ST650 / SR650

Digital in / out put

20P series



Dark gray



DHH20-□K25L

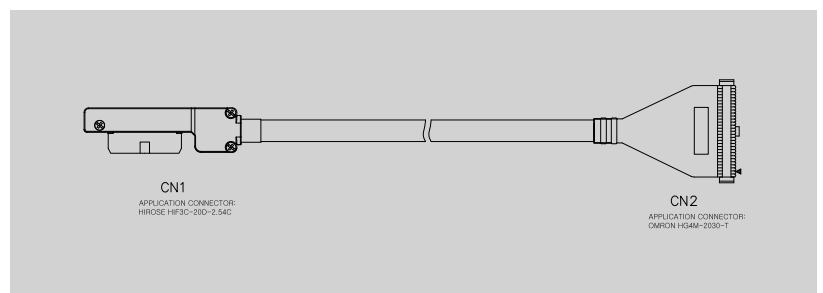

Technical data

Connection data	
Connection to PLC	HE 10 connectors 20-pin
Connection type	Onetooth connection
Connection size	0.17mm ² (AWG25)

Rated data	
Number of signals	20 point
Rated voltage	120VAC / 50VDC
MAX. connector pin	1.3A
MAX. permissible summation current	14A

General data	
Ambient temperature	-10°C ~ 50°C
Storage temperature	-10°C ~ 60°C
Insulation test voltage	0.5KV DC
Weight	Approx. ---g

Dimensions	
Length x width x height (mm)	

Ordering data

Order No.	042217002
-----------	-----------

Accessories / Spare part

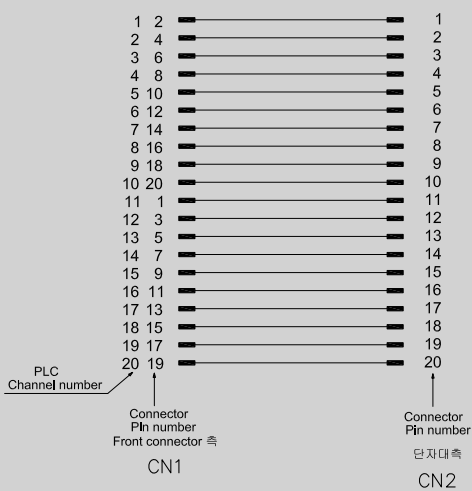

Assembled round 40P cable

Assembled round cable for SIMENS S7-300

ST650 AIO / ST800 / SR800

40P series

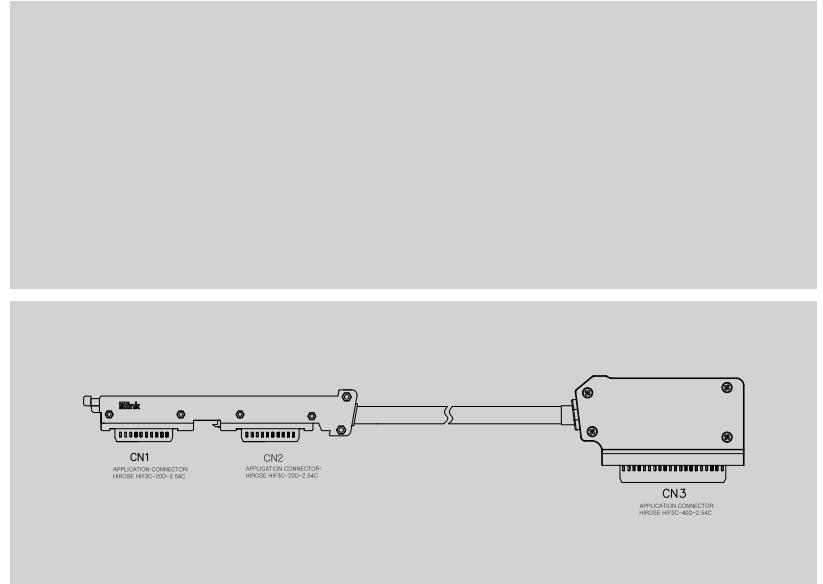

DAHHC40-□K24B / DAHHC40-□K25B

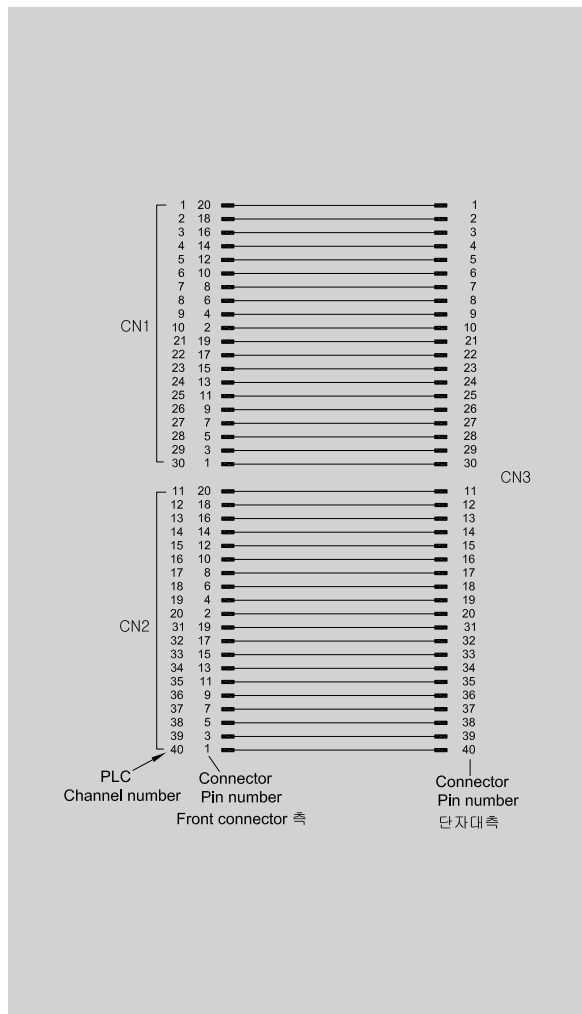

Technical data

Connection data	
Connection to PLC	HE 10 connectors 20-pole x 2 / 40-pin
Connection type	Onetouth connection
Connection size	0.25mm ² (AWG24) / 0.17mm ² (AWG25)

Rated data	
Number of signals	40 point
Rated voltage	120VAC / 50VDC
MAX. connecor pin	1.5A (AWG24)
MAX. permissible summtion current	34A

General data	
Ambient temperature	-10°C ~ 50°C
Storage temperature	-10°C ~ 60°C
Insulation test voltage	0.5KV DC
Weight	Approx. ---g

Dimensions	
Length x width x height (mm)	

Ordering data	
Order No.	
044417003 (AWG24)	044417004 (AWG25)

Accessories / Spare part

Assembled round 40P cable

Assembled round cable for SIMENS S7-300

ST650 / SR650

Digital in / out put

40P series



Dark gray



DHH40-□K25L

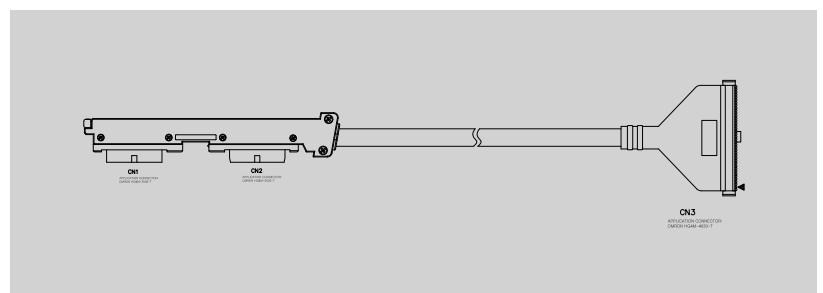

Technical data

Connection data	
Connection to PLC	HE 10 connectors 20-pin x 2 / 40-pin
Connection type	Onetooth connection
Connection size	0.17mm ² (AWG25)

Rated data	
Number of signals	40 point
Rated voltage	120VAC / 50VDC
MAX. connecor pin	1.0A (AWG25)
MAX. permissible summtion current	28A

General data	
Ambient temperature	-10°C ~ 50°C
Storage temperature	-10°C ~ 60°C
Insulation test voltage	0.5KV DC
Weight	Approx. ---g

Dimensions	
Length x width x height (mm)	

Ordering data

Order No.	
044217005	

Accessories / Spare part

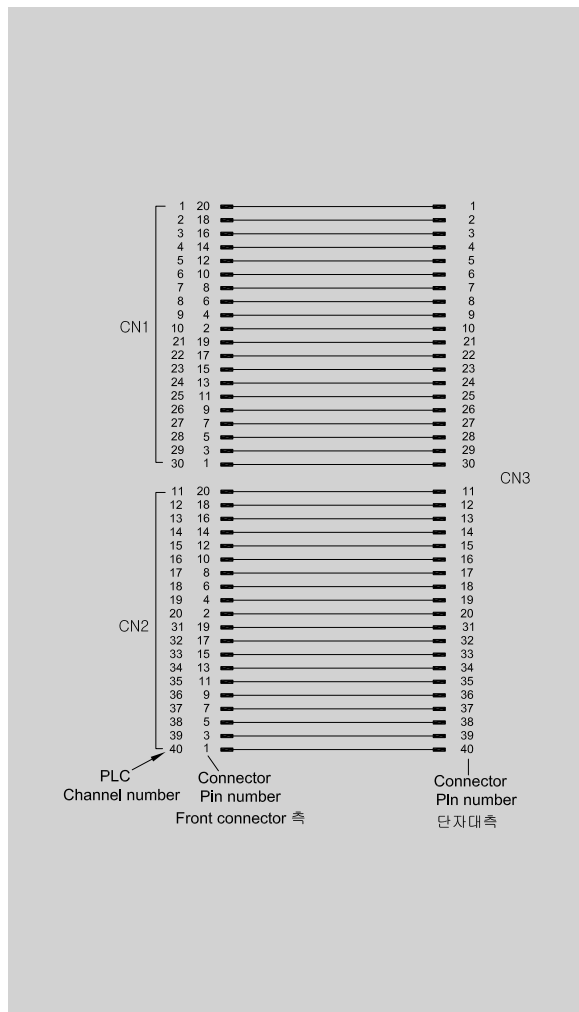

Assembled round 40P cable 6ES7 350-2AH01-OAEO only

Assembled round cable for SIMENS S7-300 (ST800-FM08SC-C2)

Counter

Counter module

40P series

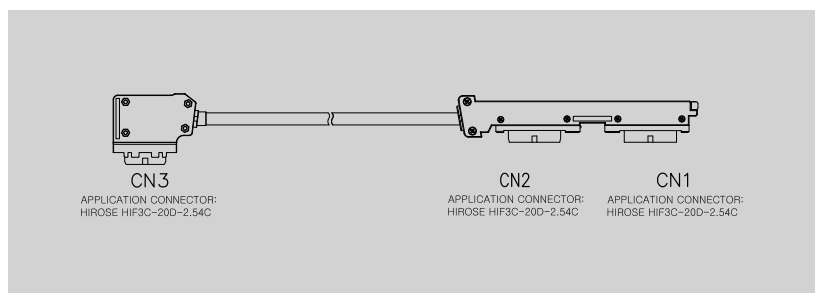

DAHHC4020-□K24B

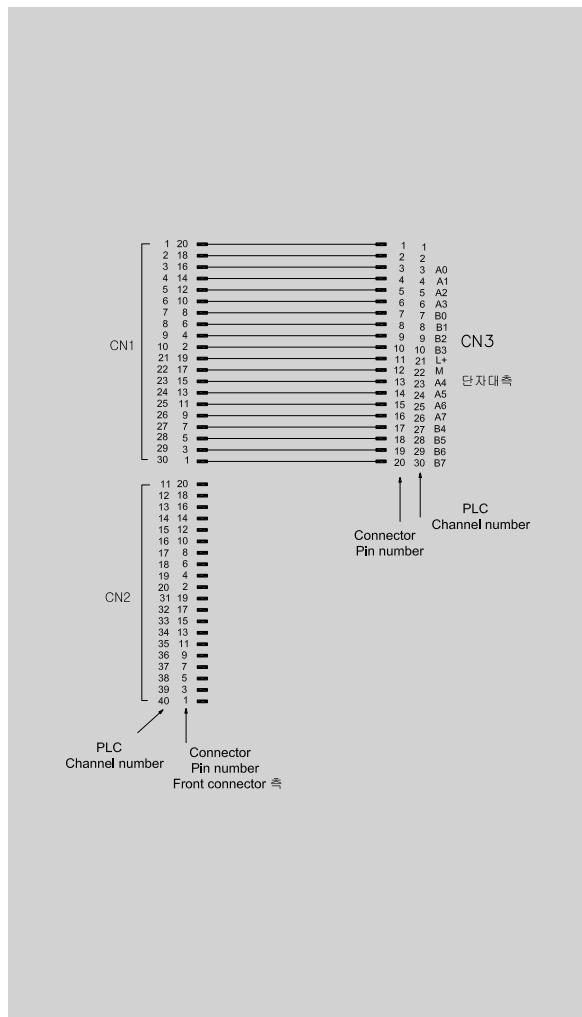

Technical data

Connection data	
Connection to PLC	HE 10 connectors 20-pin x 2 / 20-pin
Connection type	Onetouth connection
Connection size	0.25mm ² (AWG24)

Rated data	
Number of signals	20 point
Rated voltage	120VAC / 30VDC
MAX. connecor pin	1.5A
MAX. permissible summtion current	17A

General data	
Ambient temperature	-10°C ~ 50°C
Storage temperature	-10°C ~ 60°C
Insulation test voltage	0.5KV DC
Weight	Approx. ---g

Dimensions	
Length x width x height (mm)	

Ordering data

Order No.	
042417006	

Accessories / Spare part

Assembled round 40P cable

Assembled round cable for SIMENS S7-300

6ES7332-5HF00-0AB0

Analog output (current)

40P series



DAHHC4020-□K24B2

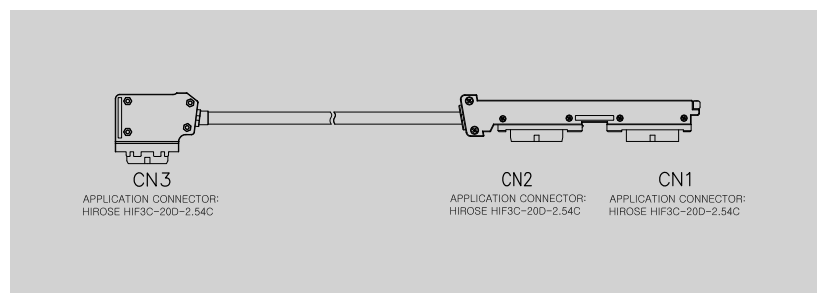

Technical data

Connection data	
Connection to PLC	HE 10 connectors 20-pin x 2 / 20-pin
Connection type	Onetooth connection
Connection size	0.25mm ² (AWG24)

Rated data	
Number of signals	20 point
Rated voltage	120VAC / 30VDC
MAX. connecor pin	1.5A
MAX. permissible summtion current	17A

General data	
Ambient temperature	-10°C ~ 50°C
Storage temperature	-10°C ~ 60°C
Insulation test voltage	0.5KV DC
Weight	Approx. ---g

Dimensions	
Length x width x height (mm)	

Ordering data	
Order No.	044417007

Accessories / Spare part

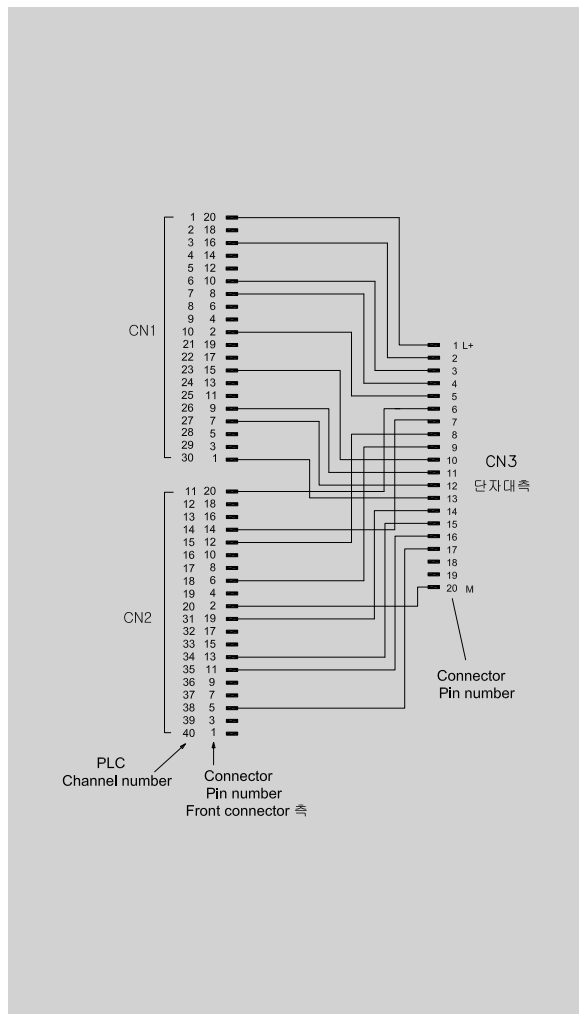

Assembled round 20P cable 6ES7 350-2AH00-0AEO only

Assembled round cable for SIMENS S7-300 (ST800-FM08SC-C)

Counter

Counter module

40P series

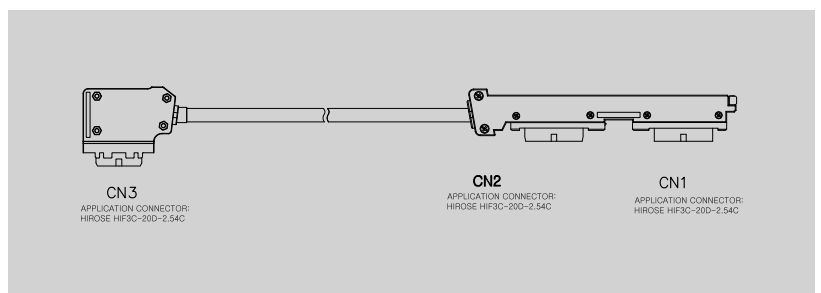

DAHHC4010-□K24B

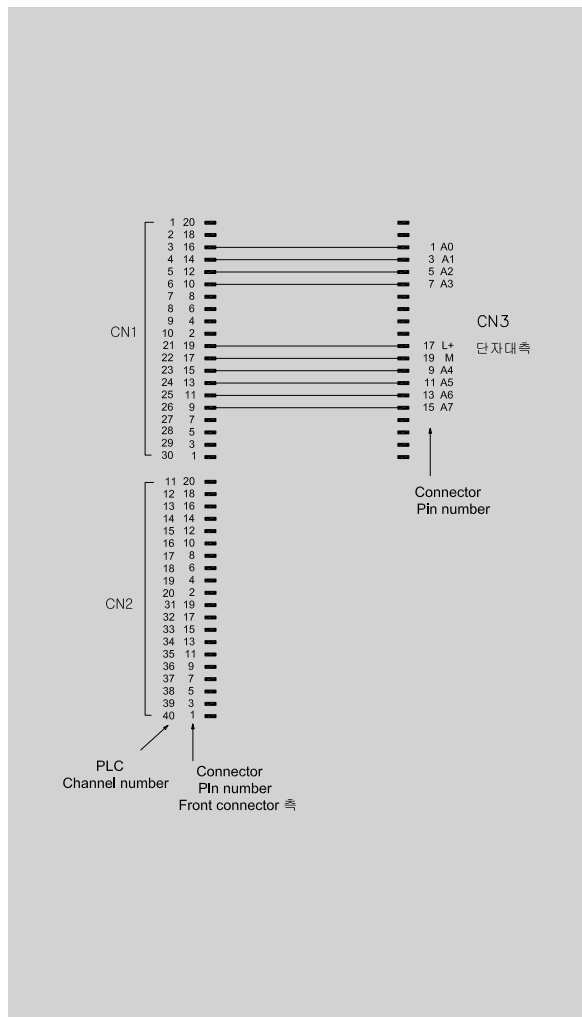

Technical data

Connection data	
Connection to PLC	HE 10 connectors 20-pin x 2 / 20-pin
Connection type	Onetouth connection
Connection size	0.25mm ² (AWG24)

Rated data	
Number of signals	10 point
Rated voltage	120VAC / 30VDC
MAX. connecor pin	1.5A
MAX. permissible summtion current	12A

General data	
Ambient temperature	-10°C ~ 50°C
Storage temperature	-10°C ~ 60°C
Insulation test voltage	0.5KV DC
Weight	Approx. ---g

Dimensions	
Length x width x height (mm)	

Ordering data

Order No.	
044417008	

Accessories / Spare part

Assembled round 20P cable

Assembled round cable for ETOS (LT508-DI0416-EID)

ETOS

ETOS communication board

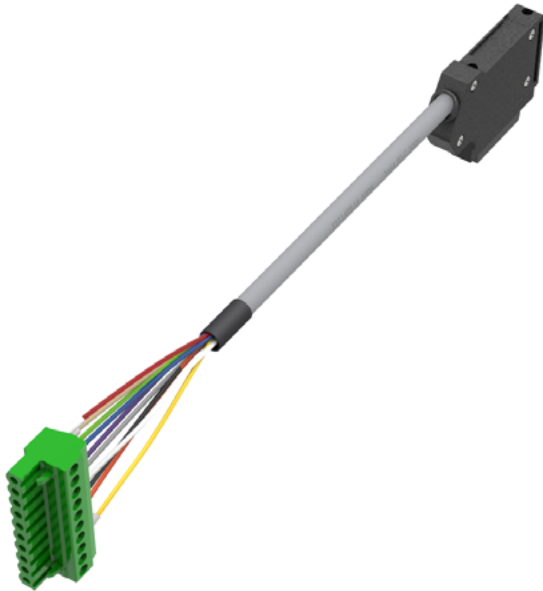

DADHC1020-□K24B

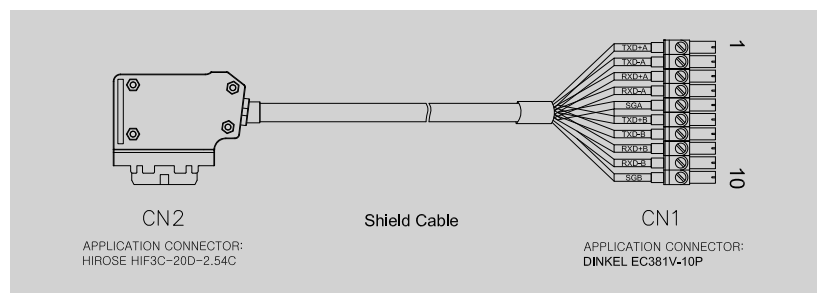

Technical data

Connection data	
Connection to ETOS	EC381V-10P
Connection type	Onetooth connection
Connection size	0.25mm ² (AWG24)

Rated data	
Number of signals	10 point
Rated voltage	120VAC / 30VDC
MAX. connecor pin	1.5A
MAX. permissible summtion current	12A

General data	
Ambient temperature	-10°C ~ 50°C
Storage temperature	-10°C ~ 60°C
Insulation test voltage	0.5KV DC
Weight	Approx. ---g

Dimensions	
Length x width x height (mm)	

Ordering data

Order No.	
041619009	

Accessories / Spare part

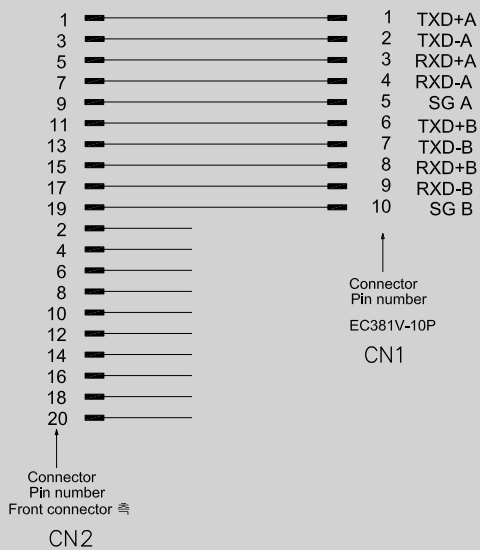

Assembled round 40P cable

Assembled round cable for FUJI AAI05 / AAI005 / AIS02

FUJI series

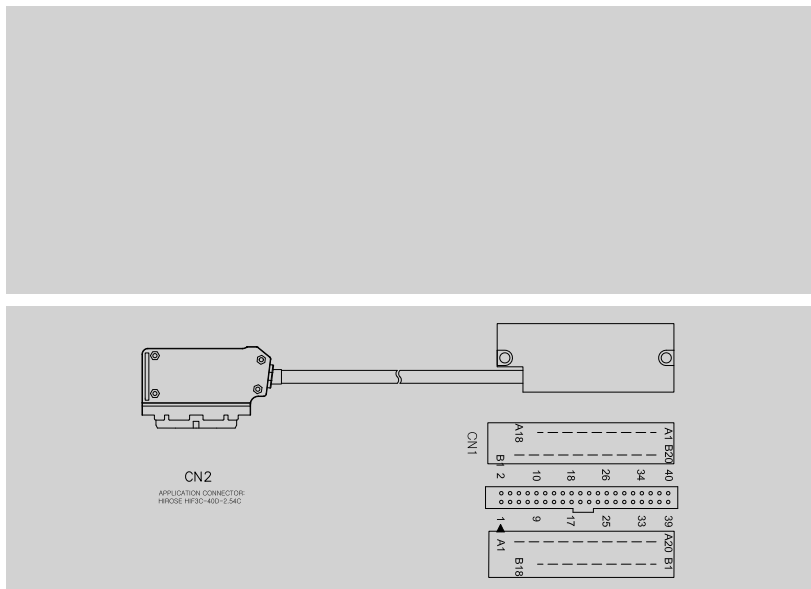

DAFUHC40-10K24B

PLC Front connector Pin number	Front connector 핀 번호 CN1	Connector Pin number	Connector 핀 번호 CN2
B20	40	1	A1
A20	39	2	B1
B19	38	3	A2
A19	37	4	B2
B18	36	5	A3
A18	35	6	B3
B17	34	7	A4
A17	33	8	B4
B16	32	9	A5
A16	31	10	B5
B15	30	11	A6
A15	29	12	B6
B14	28	13	A7
A14	27	14	B7
B13	26	15	A8
A13	25	16	B8
B12	24	17	A9
A12	23	18	B9
B11	22	19	A10
A11	21	20	B10
B10	20	21	A11
A10	19	22	B11
B9	18	23	A12
A9	17	24	B12
B8	16	25	A13
A8	15	26	B13
B7	14	27	A14
A7	13	28	B14
B6	12	29	A15
A6	11	30	B15
B5	10	31	A16
A5	9	32	B16
B4	8	33	A17
A4	7	34	B17
B3	6	35	A18
A3	5	36	B18
B2	4	37	FG
A2	3	38	FG
B1	2	39	AGND
A1	1	40	AGND

CN3

PLC Front connector
Pin number

Front connector
핀 번호
CN1

Connector
Pin number
핀 번호
CN2

Technical data

Connection data	
Connection to PLC	HE 10 connectors 40-pin
Connection type	Onetooth connection
Connection size	0.25mm ² (AWG24)

Rated data	
Number of signals	40 point
Rated voltage	120VAC / 50VDC
MAX. connecor pin	1.5A (AWG24)
MAX. permissible summation current	34A

General data	
Ambient temperature	-10°C ~ 50°C
Storage temperature	-10°C ~ 60°C
Insulation test voltage	0.5KV DC
Weight	Approx. ---g

Dimensions	
Length x width x height (mm)	

Ordering data	
Order No.	044419010

Accessories / Spare part

Assembled round 40P cable

Assembled round cable for FUJI ADIV02

FUJI series



Dark gray

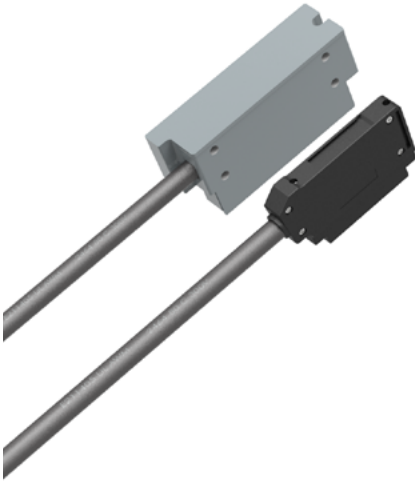

DAFUHC5040-□K24B

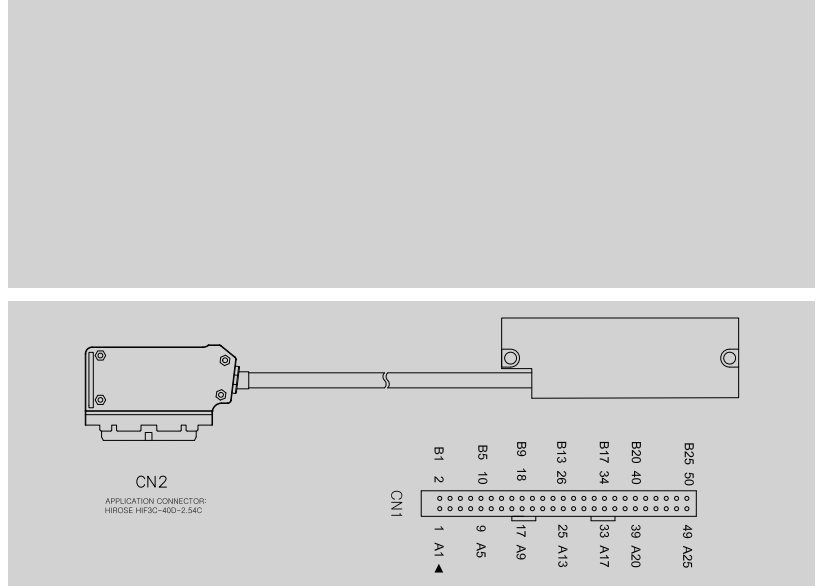

Technical data

Connection data	
Connection to PLC	HE 10 connectors 50-pin / 40-pin
Connection type	Onetooth connection
Connection size	0.25mm ² (AWG24)

Rated data	
Number of signals	40 point
Rated voltage	120VAC / 50VDC
MAX. connector pin	1.5A
MAX. permissible summation current	34A

General data	
Ambient temperature	-10°C ~ 50°C
Storage temperature	-10°C ~ 60°C
Insulation test voltage	0.5KV DC
Weight	Approx. ---g

Dimensions	
Length x width x height (mm)	

Ordering data	
Order No.	045419011

Accessories / Spare part

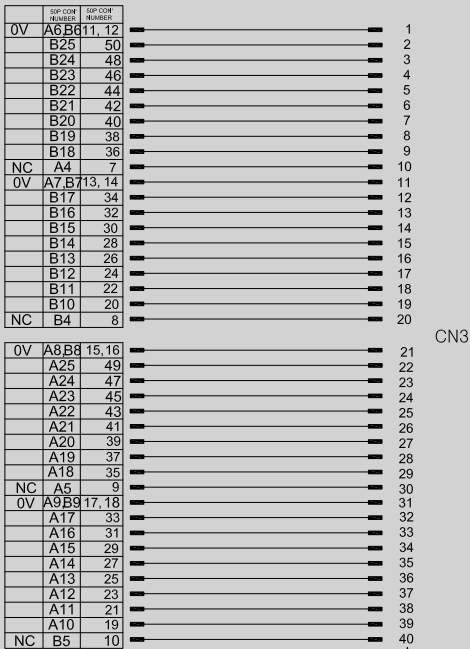

Pin number

Front connector 측
CN1

Connector
Pin number
단자대 측
CN2