

FUJI PLC - Interface unit

FUJI PLC PROGRESSIO series 전용 Interface unit입니다.

F

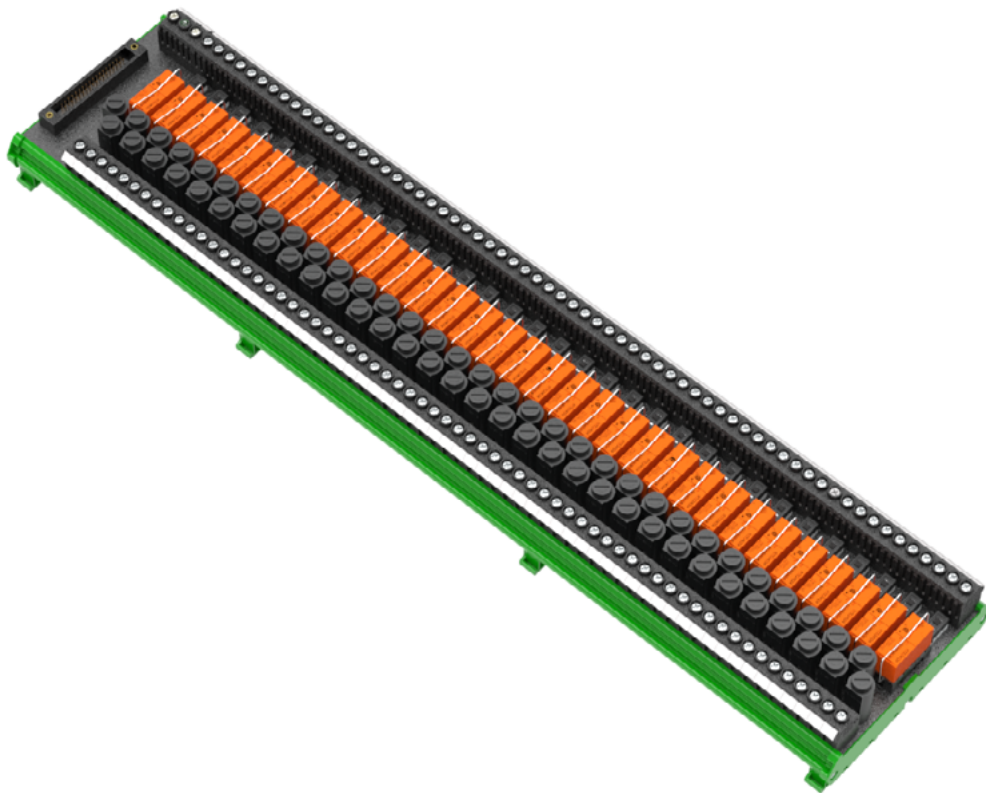

FUJI PLC PROGRESSIO series

Product constitution

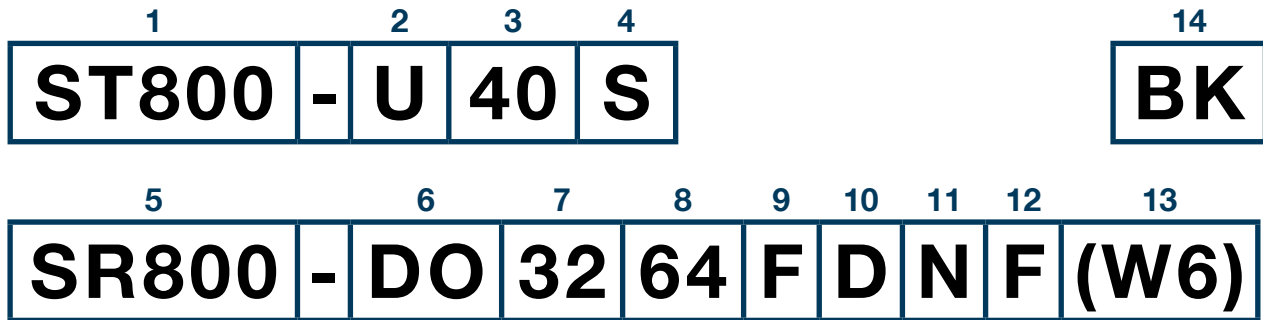

1. ST800

- Terminal block
- 800 : 8.0 Pitch

2. U

- Universal type

3. 40

- Signal point

4. S

- Signal use

5. SR800

- Relay Board
- 800 : 8.0 Pitch

6. DO

- Card form
- DI : Digital input
- DO : Digital output

7. 32

- Signal point

8. 64

- The load side

9. F

- Applied PLC
- F : FUJI

10. D

- Contact mode
- D : Dry contact
- W : Wet contact

11. N

- Optional
- N : NPN

12. F

- F : Fuse
- D : Disconnection
- S : Selection

13. W6

- Type of relay
- W6 : WAGO 6A
- S8 : Tyco 8A

14. BK

- PCB color
- BK : Black

Universal type 40 point

For 40 analog signals

FUJI AAI05 / AAI005 / AIS02

ST800 40P series

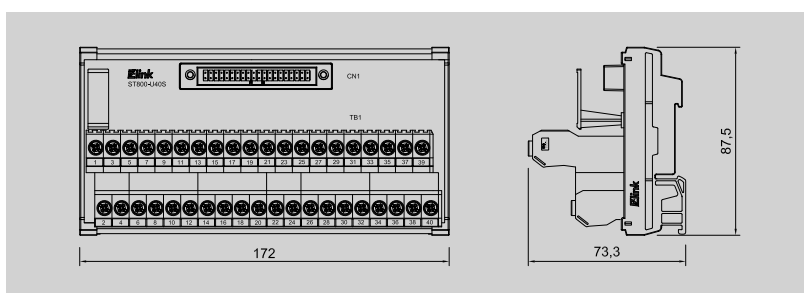
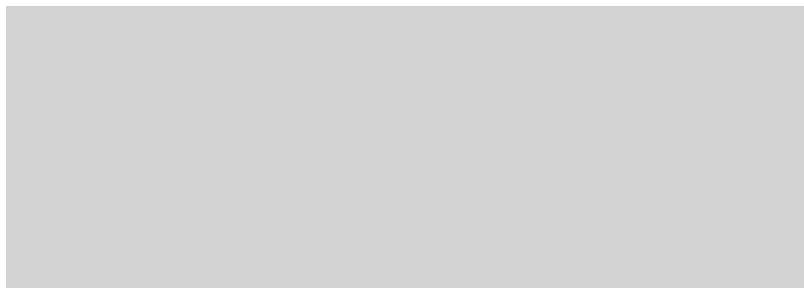
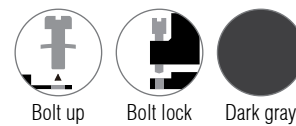

F

ST800-U40S BK

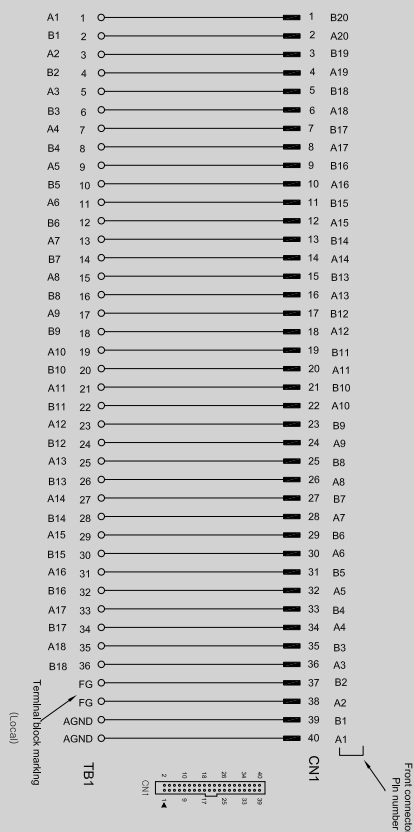

Technical data

Connection data	
Connection to PLC	HE 10 connectors 40-pin
Connection type (field)	Screw bolt up
Connection size (field)	0.34 ~ 2.5mm ² (AWG22 ~ 14)

Input-output data	
Operating voltage	24VDC ± 10%
Max. current for channel	1.5A
Number of signals	40
PLC card supply voltage / LED voltage status	24VDC ± 10% / LED green
LED fuse indication per channel	-
PLC card supply current	-
Fuse per channel	-

General data	
Ambient temperature	-25°C ~ 50°C
Storage temperature	-40°C ~ 60°C
Rated voltage	≤ 50V AC
Insulation test voltage	0.5KV DC
Weight 6.50 / 8.00	Approx. ---g / 360.6g

Dimensions	
Length x width x height (mm)	6.50 Pitch -
	8.00 Pitch 172 x 87.5 x 73.3

Mounting rail	TS35 (Weidmuller)
---------------	-------------------

Ordering data

Order No.	
--- (6.50 Pitch)	824119026 (8.00 Pitch)

Accessories / Spare part	
Terminal markers	6.50 8.00 DEK 5/8
Cross-connector	6.50 COM-6509 8.00 COM-8009

Use with

Front connector	Cable DAFUHC40-10K24B	Page : 112
-----------------	-----------------------	------------

Digital input relay unit

For 32 isolated digital input signals

FUJI ADIV02 Relay - WAGO 6A 32 point (32a)

SR800 40P series



Bolt up



Bolt lock



Dark gray



SR800-DI3264FW (W6) BK

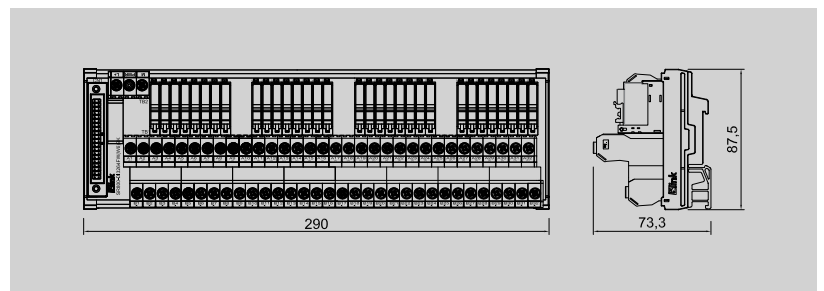

Technical data

Connection data	
Connection to PLC	HE 10 connectors 40-pin
Connection type (field)	Screw bolt up
Connection size (field)	0.34 – 2.5mm ² (AWG22 – 14)
Nominal input data (coil)	
Rated voltage	24VDC ± 10%
Rated current DC	9.2mA
Pick-up / drop-out volt. DC-coil	>16.8V / <3.5V
Coil resistance (+/- 10%)	2,600
Power rating	220mW
LED status indication per channel	Green(5mA)
Nominal output data	
Contact material	AgSnO ₂
Operating voltage	250VAC
Max. switching current	6A
Nominal switching capacity	6A 250VAC, 6A 30VDC
Minimum contact current	1mA
Minimum contact voltage	24V
General data	
Ambient temperature (operational)	-25°C – 50°C
Storage temperature	-40°C – 60°C
Weight 6.50 / 8.00	Approx. ---g / 836.5g
Dimensions	
Length x width x height (mm)	6.50 Pitch -
	8.00 Pitch 290 x 87.5 x 73.3
Mounting rail	TS35 (Weidmuller)
Ordering data	
Order No.	
--- (6.50 Pitch)	834219022 (8.00 Pitch)
Accessories / Spare part	
Terminal markers	6.50 8.00 DEK 5/8
Cross-connector	6.50 8.00 COM-8009
Use with	
Front connector	Cable
	DAFUHC5040-10K24B

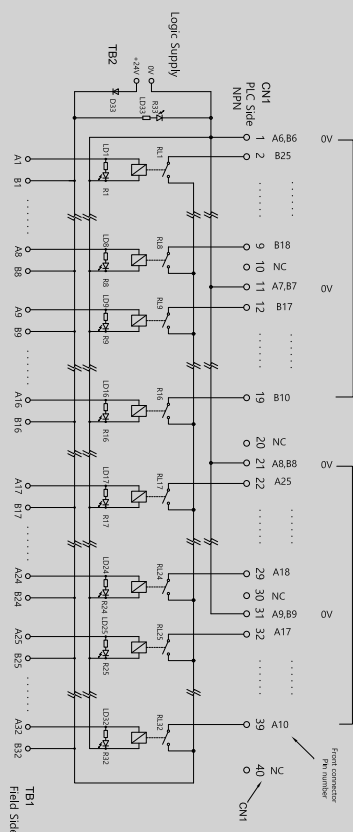

Digital output relay unit

For 32 isolated digital output signals

FUJI ADOT02 Relay - WAGO 6A 32 point (32a)

SR800 40P series

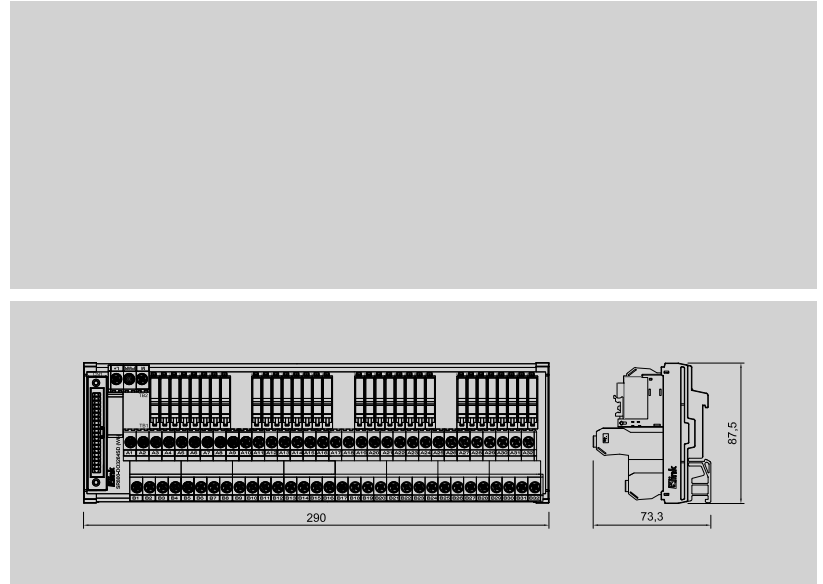
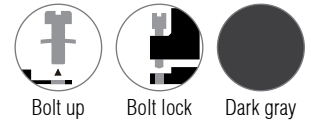

F

SR800-D03264SD (W6) BK NPN

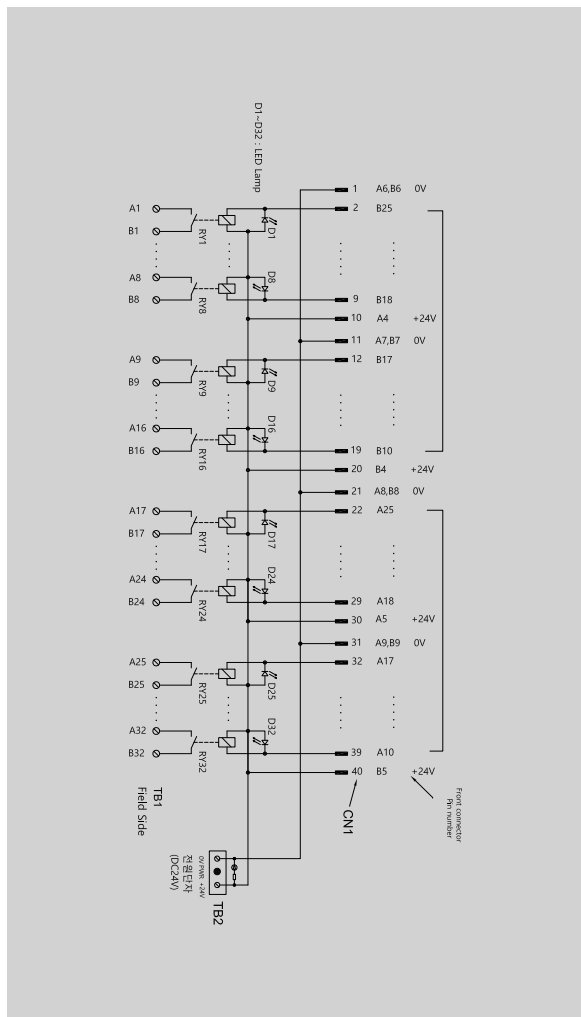

Technical data

Connection data	
Connection to PLC	HE 10 connectors 40-pin
Connection type (field)	Screw bolt up
Connection size (field)	0.34 ~ 2.5mm ² (AWG22 ~ 14)
Nominal input data (coil)	
Rated voltage	24VDC ± 10%
Rated current DC	9.2mA
Pick-up / drop-out volt. DC-coil	>16.8V / <3.5V
Coil resistance (+ / - 10%)	2,600
Power rating	220mW
LED status indication per channel	Green(5mA)
Nominal output data	
Contact material	AgSnO ₂
Operating voltage	250VAC
Max. switching current	6A
Nominal switching capacity	6A 250VAC, 6A 30VDC
Minimum contact current	1mA
Minimum contact voltage	24V
General data	
Ambient temperature (operational)	-25°C ~ 50°C
Storage temperature	-40°C ~ 60°C
Weight 6.50 / 8.00	Approx. ---g / 836.5g
Dimensions	
Length x width x height (mm)	6.50 Pitch -
	8.00 Pitch 290 x 87.5 x 73.3
Mounting rail	
TS35 (Weidmuller)	
Ordering data	
Order No.	
--- (6.50 Pitch)	834219023 (8.00 Pitch)
Accessories / Spare part	
Terminal markers	6.50 8.00 DEK 5/8
Cross-connector	6.50 8.00 COM-8009
Use with	
Front connector	Cable DAFUHC5040-10K24B

Digital output relay unit

For 32 isolated digital output signals (fuses) input selection ON / OFF / AUTO

FUJI ADOT02 Realy - Tyco 8A 32 point (32a, 32b)

SR800 40P series

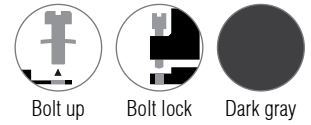

Bolt up

Bolt lock

Dark gray

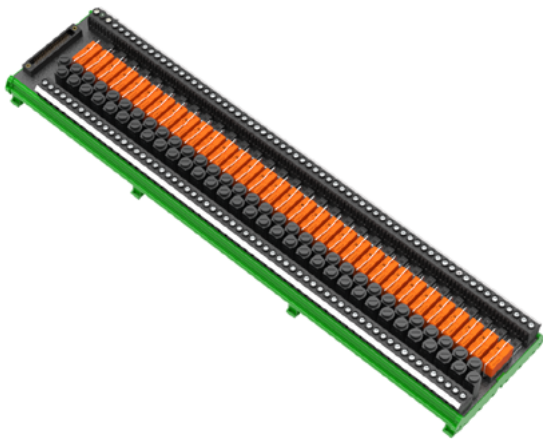

SR800-D032128SDSF (S8) BK NPN

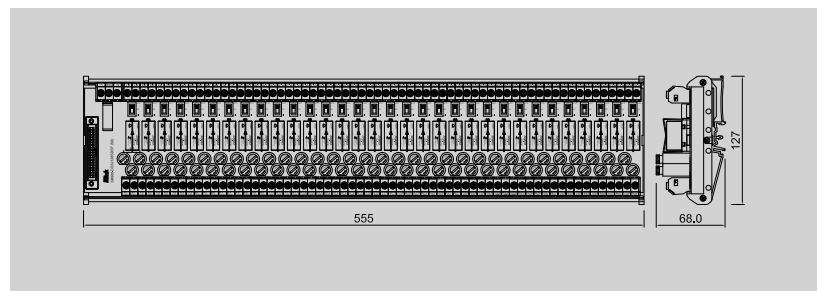

Technical data

Connection data	
Connection to PLC	HE 10 connectors 40-pin
Connection type (field)	Screw bolt up
Connection size (field)	0.34 ~ 2.5mm ² (AWG22 ~ 14)
Nominal input data (coil)	
Rated voltage	24VDC ± 10%
Rated current DC	16.7mA
Pick-up / drop-out volt. DC-coil	>16.8V / <2.4V
Coil resistance (+ / - 10%)	1,440
Power rating	400mW
LED status indication per channel	Green(5mA)
Nominal output data	
Contact material	AgSnO ₂
Operating voltage	250VAC
Max. switching current	8A
Nominal switching capacity	8A 250VAC, 8A 30VDC
Minimum contact current	10mA
Minimum contact voltage	10V
Fuse per relay	5 / 8A
General data	
Ambient temperature (operational)	-25°C ~ 50°C
Storage temperature	-40°C ~ 60°C
Weight 6.50 / 8.00	Approx. ---g / 1,560.8g
Dimensions	
Length x width x height (mm)	8.00 Pitch 555 x 127 x 68
Mounting rail	TS35 (Weidmuller)
Ordering data	
Order No.	
--- (6.50 Pitch)	834219024 (8.00 Pitch)
Accessories / Spare part	
Terminal markers	6.50 8.00 DEK 5/8
Cross-connector	6.50 8.00 COM-8009
Use with	
Front connector	Cable DAFUHC5040-10K24B

